

Article datasheet

Locking and Sealing Washer $\text{\O}4.2/8.0 \times 2.5$ Polyamide 6 natural

Article-No.: 003.07.446

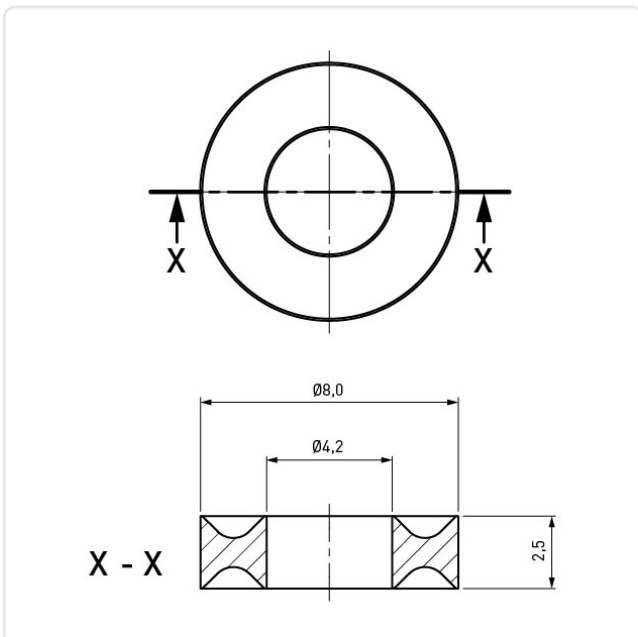

Image may be similar

For Thread Size: M4
Height [mm]: 2.5
Inner Diameter [mm]: 4.2
Material: Polyamide 6.0
Material Group: Plastic
Outer Diameter [mm]: 8
Weight: 0.08g
Conformities:



You can find all
information on the web on
our article detail page



Would you like individual advice?

We look forward to your email to products@ettinger.de.

Subject to change and errors.