

Article datasheet

Self-Tapping Screw for Plastic 3x20 PT Galvanized Q&T Steel Pozi Countersunk

Article-No.: 001.92.371



Image may be similar

Actuator Size:	Pozidriv PZ1
Drive Type:	Cross Recess / Pozidriv-Z
Finish:	Galvanized, Blue, 5 µm, A2K
Head Diameter [mm]:	5.5
Head Height [mm]:	2.05
Head Shape:	Countersunk Head
Length [mm]:	20
Material:	Q&T Steel
Material Group:	Steel
Thread Diameter [mm]:	Ø 3.0
Thread Type:	PT Thread
Weight:	0.66g
Conformities:	

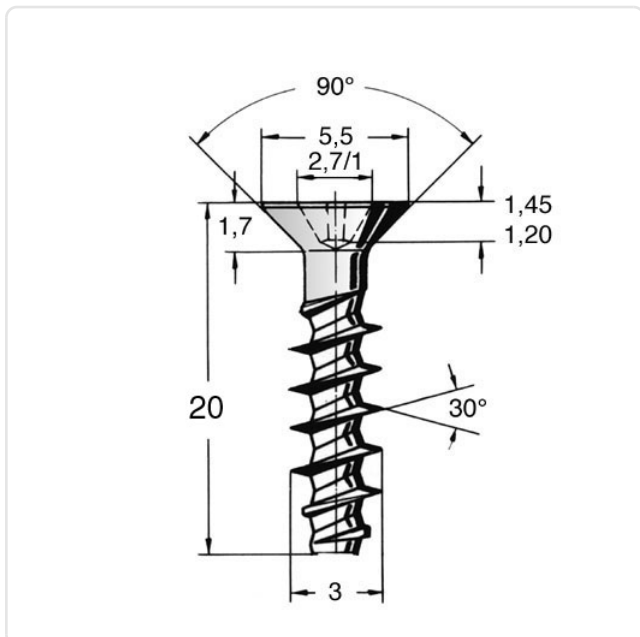

You can find all
information on the web on
our article detail page

Would you like individual advice?

We look forward to your email to products@ettinger.de.

Subject to change and errors.