

Article datasheet

Insulated Standoff PA-Brass F/F ø8x15 | Thread M4x6 / M4x6

Article-No.: 005.48.415



Image may be similar

AF / OD [mm]: 8
Flammability Class: UL94-HB
Length [mm]: 15
Material: PA 6.6
Material Group: Kunststoff
Profile: Round
Thread 1 Length [mm]: 6
Thread 1 Size: M4
Thread 2 Length [mm]: 6
Thread 2 Size: M4
Thread Insert Material: Brass
Weight: 1.52g
Conformities:

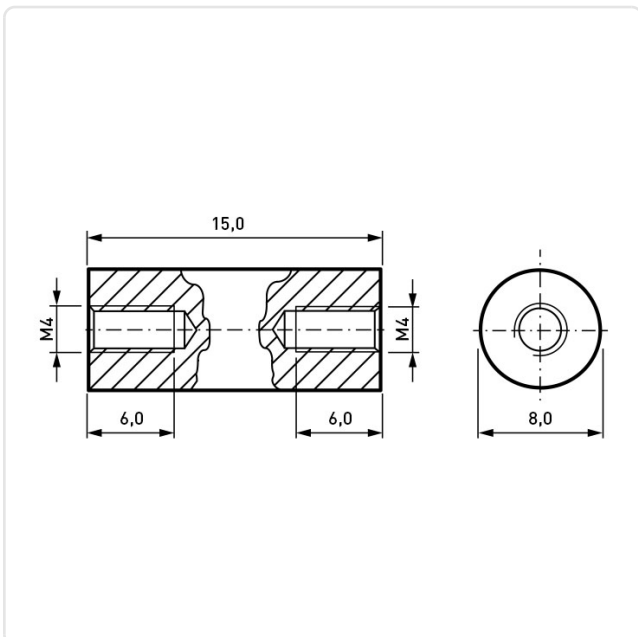

You can find all
information on the web on
our article detail page

Would you like individual advice?

We look forward to your email to products@ettinger.de.

Subject to change and errors.