

Article datasheet

Spring Washer DIN137 B $\text{\O}5.3/11.0 \times 0.5$ Galvanized Spring Steel

Article-No.: 003.23.051

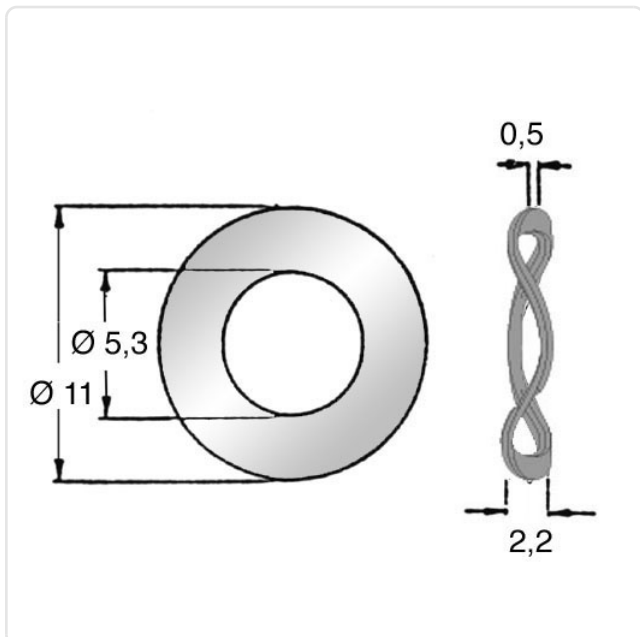

Image may be similar

DIN/ISO:	DIN137B
Finish:	Galvanized, Blue, 5 μm , A2K
For Thread Size:	M5
Height [mm]:	0.5
Inner Diameter [mm]:	5.3
Material:	Spring Steel
Material Group:	Steel
Outer Diameter [mm]:	11
Weight:	0.25g
Conformities:	



You can find all information on the web on our article detail page



Would you like individual advice?

We look forward to your email to products@ettinger.de.

Subject to change and errors.