

Article datasheet

Countersunk Screw ISO10642 M3x6 A2 Plain Stainless Steel Hexagon Socket

Article-No.: 001.19.322



Image may be similar

Actuator Size:	Hexagon Socket Hex2
DIN/ISO:	DIN7991 / ISO10642
Drive Type:	Hexagon Socket
Finish:	Plain
Head Diameter [mm]:	6.72
Head Height [mm]:	1.86
Head Shape:	Countersunk Head
Length [mm]:	6
Material:	Stainless Steel AISI 304 / A2
Material Group:	Stainless Steel
Thread Size:	M3
Weight:	0.46g
Conformities:	

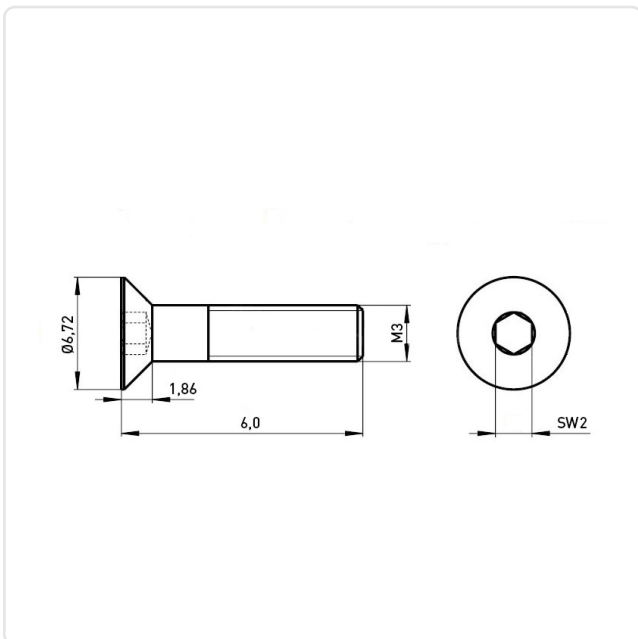

You can find all
information on the web on
our article detail page

Would you like individual advice?

We look forward to your email to products@ettinger.de.

Subject to change and errors.