

Article datasheet

Lock Nut DIN985/ISO10511 M6 A4 Plain Stainless Steel

Article-No.: 002.08.906

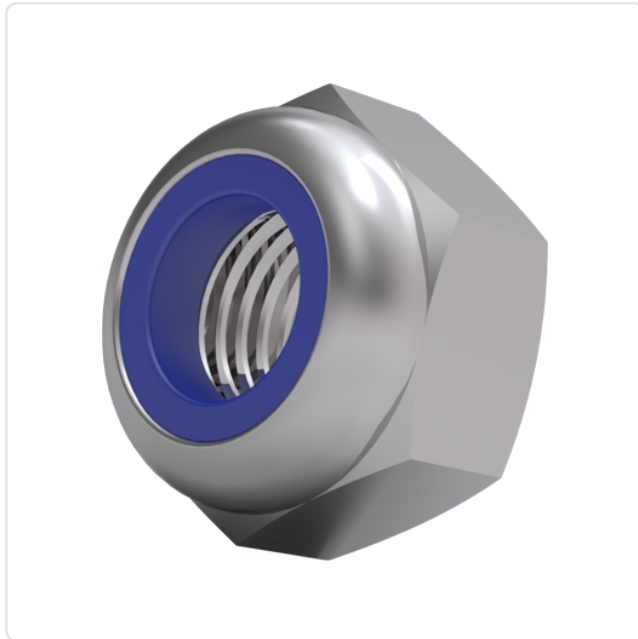
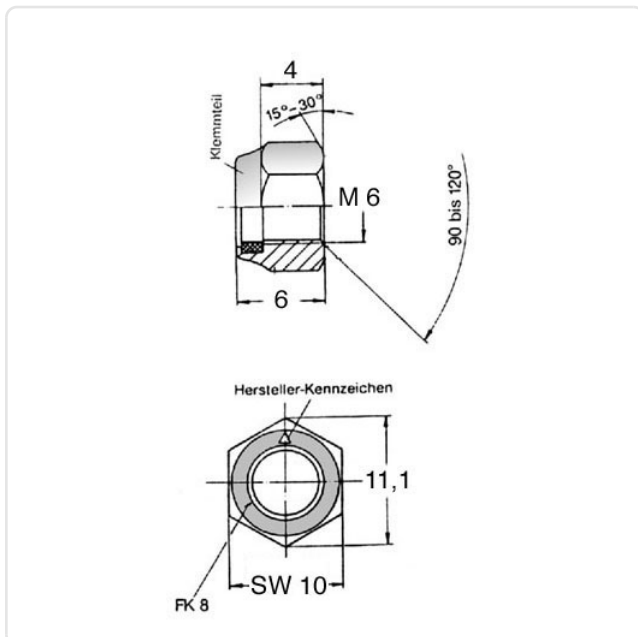

Image may be similar

AF / OD [mm]: 10
DIN/ISO: DIN985 / ISO10511
Finish: Plain
Height [mm]: 6
Material: Stainless Steel A4 / AISI 316
Material Group: Stainless Steel
Thread Size: M6
Weight: 0.44g
Conformities:



You can find all information on the web on our article detail page



Would you like individual advice?

We look forward to your email to products@ettinger.de.

Subject to change and errors.