

Article datasheet

Set Screw DIN551/ISO4766 M4x6 PA-66 Natural Slotted Flat Point

Article-No.: 001.40.426

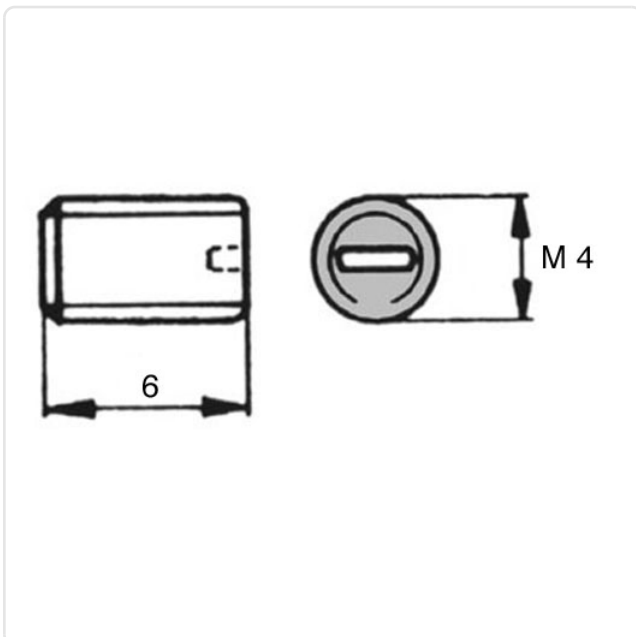

Image may be similar

Color: Natural
DIN/ISO: ISO4766
Drive Type: Slotted
Flammability Class: UL94-V2
Length [mm]: 6
Material: PA 6.6
Material Group: Plastic
Point Type: Flat Point
Thread Size: M4
Weight: 0.07g
Conformities:



You can find all
information on the web on
our article detail page



Would you like individual advice?

We look forward to your email to products@ettinger.de.

Subject to change and errors.