

Article datasheet

SEMS Screw ISO7045 PZ Z4 M3x6 Galv. Steel 4.8 Spring Lock Washer

Article-No.: 081.58.322



Image may be similar

Actuator Size:	Pozidriv PZ1
Combination:	Spring Lock Washer DIN6905
DIN/ISO:	DIN7985 / ISO7045
Drive Type:	Cross Recess / Pozidriv-Z
Finish:	Galvanized, Blue, 5 µm, A2K
Head Diameter [mm]:	6
Head Height [mm]:	2.4
Head Shape:	Pan Head
Length [mm]:	6
Material:	Steel 4.8, lead-free
Thread Size:	M3
Weight:	0.74g
Conformities:	

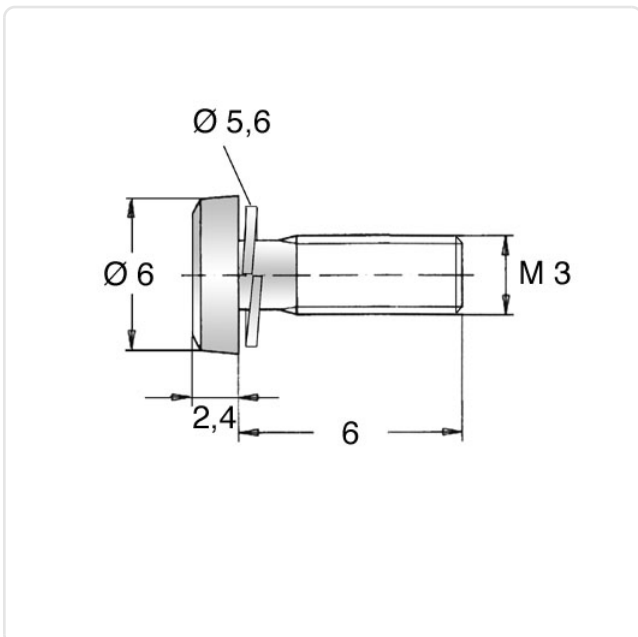

You can find all information on the web on our article detail page

Would you like individual advice?

We look forward to your email to products@ettinger.de.

Subject to change and errors.