

Article datasheet

## Thread Forming Screw DIN7500M M4x10 Galv. Steel Case Hardened Torx CSK

Article-No.: 001.36.441



Image may be similar

Actuator Size:	Torx T20
DIN/ISO:	DIN7500-M
Drive Type:	TORX
Finish:	Galvanized, Blue, 5 µm, A2K
Head Diameter [mm]:	7.5
Head Height [mm]:	2.2
Head Shape:	Countersunk Head
Length [mm]:	10
Material:	Case-Hardened Steel
Material Group:	Steel
Thread Size:	M4
Thread Type:	Metric
Weight:	0.88g
Conformities:	

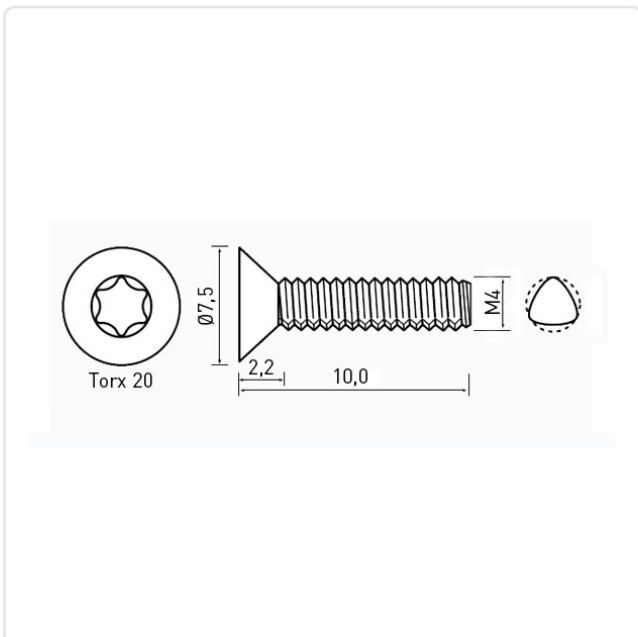

You can find all  
information on the web on  
our article detail page

Would you like individual advice?

We look forward to your email to [products@ettinger.de](mailto:products@ettinger.de).

Subject to change and errors.