

Article datasheet

Hexagonal Screw DIN931/ISO4014 M12x60 Polyamide 6.6 natural Hexagon

Article-No.: 001.42.5020

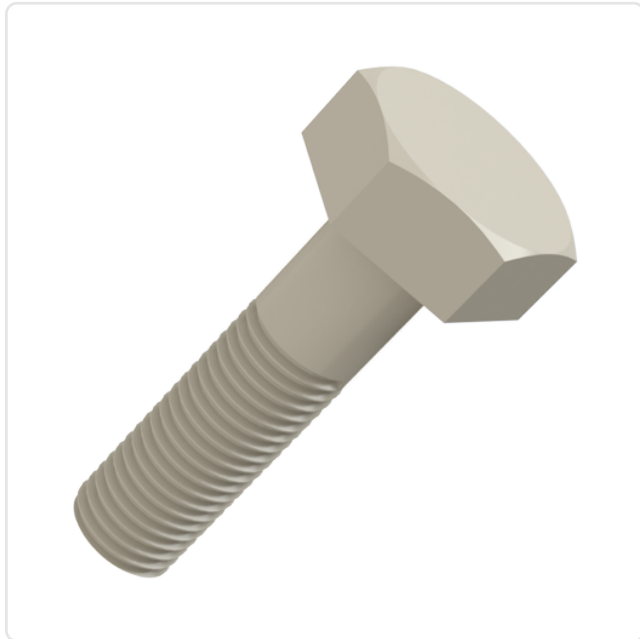
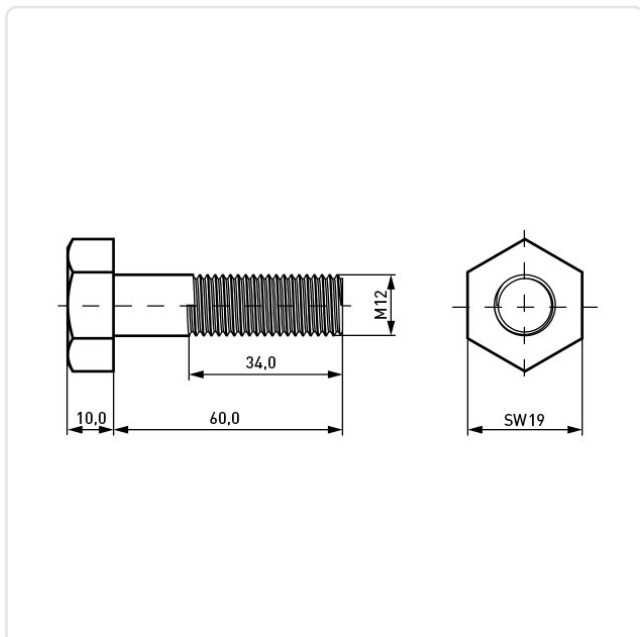

Image may be similar

Actuator Size:	Hexagon Hex19
Color:	Natural
DIN/ISO:	DIN931 / ISO4014
Drive Type:	Hexagon
Head Diameter [mm]:	19
Head Height [mm]:	10
Head Shape:	Hexagon Head
Length [mm]:	60
Material:	PA 6.6
Thread Size:	M12
Weight:	9.1g
Conformities:	



You can find all information on the web on our article detail page



Would you like individual advice?

We look forward to your email to products@ettinger.de.

Subject to change and errors.