

Article datasheet

## Countersunk Screw ISO2009 M2.5x6 Galvanized Steel 4.8 Slotted

Article-No.: 001.11.221

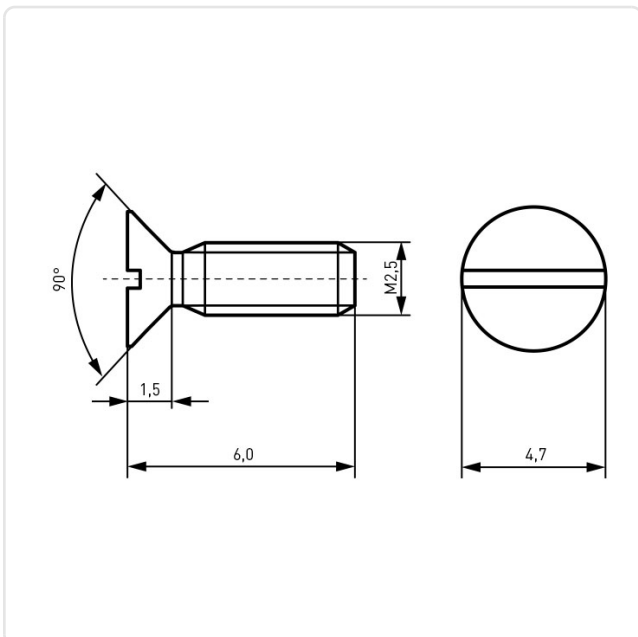

Image may be similar

DIN/ISO:	DIN963 / ISO2009
Drive Type:	Slotted
Finish:	Galvanized, Blue, 5 µm, A2K
Head Diameter [mm]:	4.7
Head Height [mm]:	1.5
Head Shape:	Countersunk Head
Length [mm]:	6
Material:	Steel 4.8
Material Group:	Steel
Thread Size:	M2.5
Weight:	0.26g
Conformities:	



You can find all  
information on the web on  
our article detail page



Would you like individual advice?

We look forward to your email to [products@ettinger.de](mailto:products@ettinger.de).

Subject to change and errors.