

Article datasheet

Hexagonal Screw DIN933/ISO4017 M6x16 A2 Plain Stainless Steel Hexagon

Article-No.: 001.13.669

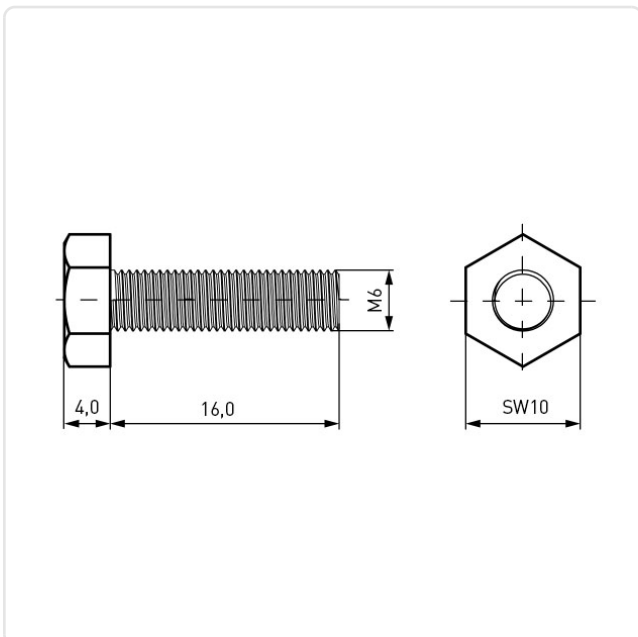

Image may be similar

Actuator Size:	Hexagon Hex10
DIN/ISO:	DIN933 / ISO4017
Drive Type:	Hexagon
Finish:	Plain
Head Diameter [mm]:	10
Head Height [mm]:	4
Head Shape:	Hexagon Head
Length [mm]:	16
Material:	Stainless Steel AISI 304 / A2
Material Group:	Stainless Steel
Thread Size:	M6
Weight:	5.42g
Conformities:	



You can find all
information on the web on
our article detail page



Would you like individual advice?

We look forward to your email to products@ettinger.de.

Subject to change and errors.