

Article datasheet

Conical Spring Washer $\varnothing 3.2/5.7 \times 0.3$ Galvanized Spring Steel

Article-No.: 003.24.931

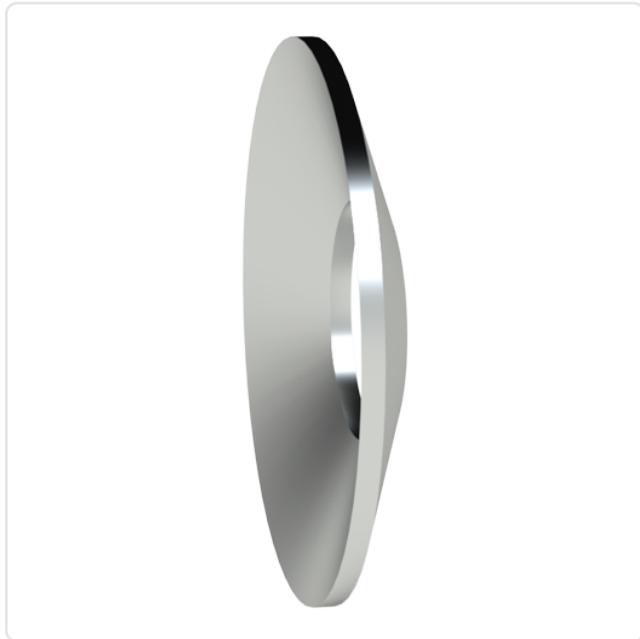
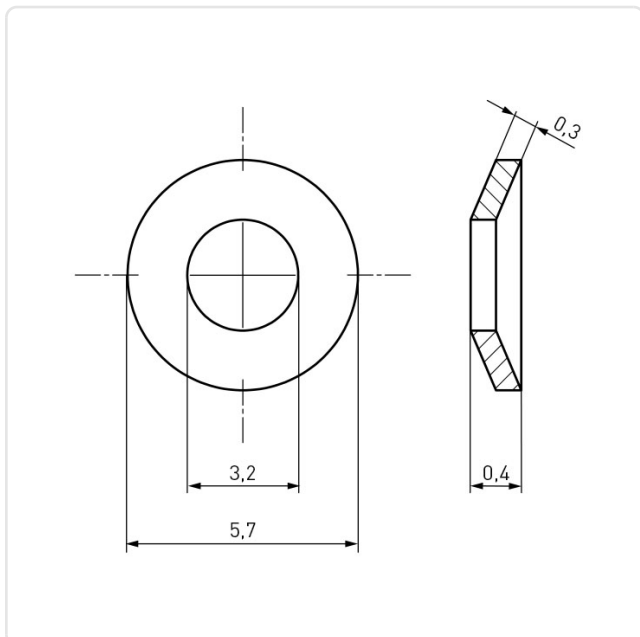

Image may be similar

Finish: Galvanized, Blue, 5 μ m, A2K
For Thread Size: M3
Height [mm]: 0.3
Inner Diameter [mm]: 3.2
Material: Spring Steel
Material Group: Steel
Outer Diameter [mm]: 5.7
Weight: 0.04g
Conformities:



You can find all information on the web on our article detail page



Would you like individual advice?

We look forward to your email to products@ettinger.de.

Subject to change and errors.