

Article datasheet

Flat Head Screw ISO7045 M5x10 A2 Plain Stainless Steel Torx Pan Head

Article-No.: 001.51.549



Image may be similar

Actuator Size:	Torx T25
DIN/ISO:	DIN7985 / ISO7045
Drive Type:	TORX
Finish:	Plain
Head Diameter [mm]:	10
Head Height [mm]:	3.8
Head Shape:	Pan Head
Length [mm]:	10
Material:	Stainless Steel AISI 316 / A4
Material Group:	Stahl rostfrei
Thread Size:	M5
Weight:	2.84g
Conformities:	

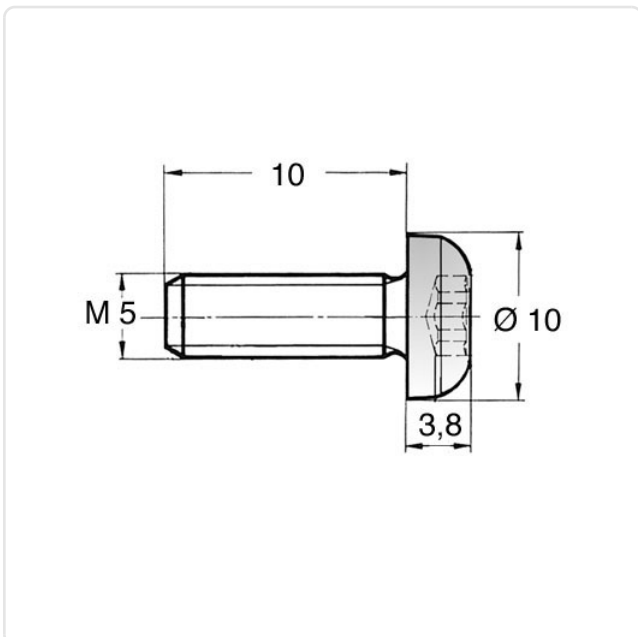

You can find all
information on the web on
our article detail page

Would you like individual advice?

We look forward to your email to products@ettinger.de.

Subject to change and errors.